

Article number: 20191B14B142BL

Description: E+G

T-angle clamps GN191-B14-B14-22-BL

Measures

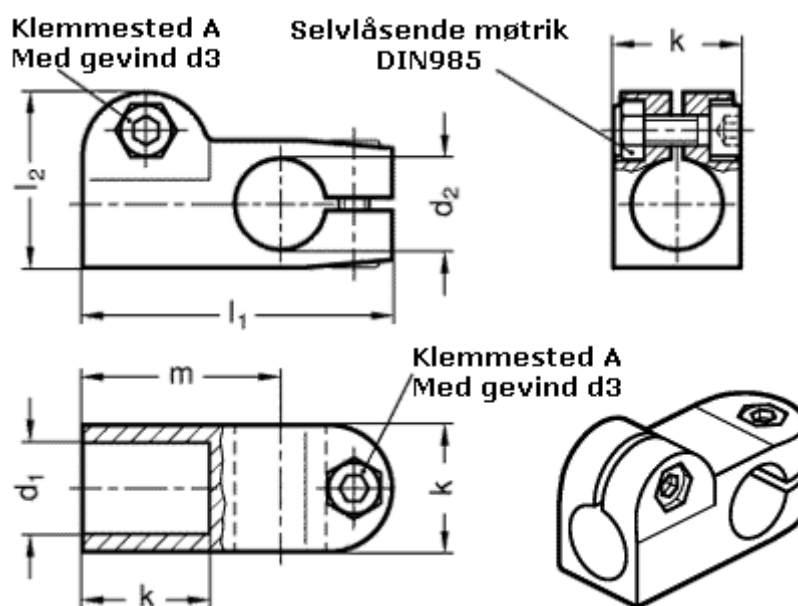

d1 = B14
d2 = B14
d3 = M 6
k = 25
l1 = 61
l2 = 34.5
m = 39